

Features

- On Chip Hall Sensor
- Rotor-Locked Shutdown
- Automatically Restart
- Built-in Zener Protection for Output Driver
- Operating Voltage: 3.8V~20 V
- Output Current: $I_{O(AVE)} = 500\text{mA}$ for SIP-4L/SOT89-5L
- Lead Free Packages: SIP-4L and SOT89-5L (Note 1)
- SIP-4L: Available in "Green" Molding Compound (No Br, Sb)
- Lead Free Finish/RoHS Compliant (Note 2)



General Description

AH284 is a monolithic fan motor controller with Hall sensor's capability. It contains two complementary open-drain drivers for motor's coil driving, automatic lock shutdown and restart function relatively.

Rotor-lock shutdown detection circuit turns off the output driver when the rotor is blocked to avoid coil overheat. Then, the automatic recovery circuit will restart the motor. These protected actions are repeated and periodic during the blocked period. Until the blocking is removed, the motor recovers and runs normally.

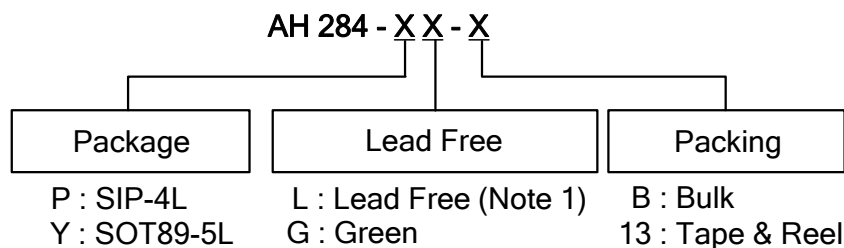
Ordering Information



Device	Package Code	Packaging (Note 3)	Bulk		13" Tape and Reel	
			Quantity	Part Number Suffix	Quantity	Part Number Suffix
 AH284-PL-B	P	SIP-4L	1000	-B	NA	NA
 AH284-PG-B	P	SIP-4L	1000	-B	NA	NA
 AH284-YL-13	Y	SOT89-5L	NA	NA	2500/Tape & Reel	-13

- Notes:
1. SOT89-5L is available in "Lead Free" product only.
 2. EU Directive 2002/95/EC (RoHS). All applicable RoHS exemptions applied, see *EU Directive 2002/95/EC Annex Notes*.
 3. Pad layout as shown on Diodes Inc. suggested pad layout document AP02001, which can be found on our website at <http://www.diodes.com/datasheets/ap02001.pdf>.
 4. Reverse taping as shown on Diodes Inc. Surface Mount (SMD) Packaging document AP02007, which can be found on our website at <http://www.diodes.com/datasheets/ap02007.pdf>.

Pin Assignment

(Top View)

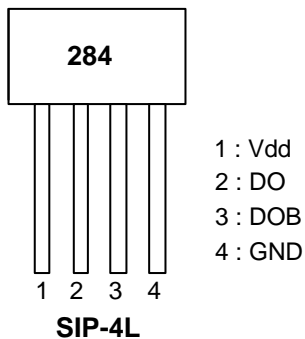

(Top View)

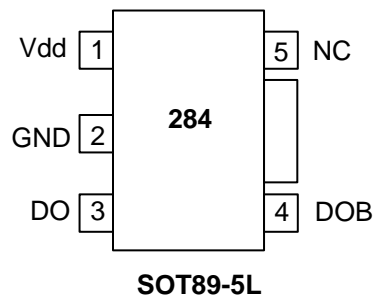

Pin Descriptions

Name	Description
V _{dd}	Input Power
DO	Output Pin
DOB	Output Pin
GND	Ground
NC	Not Connected

Block Diagram

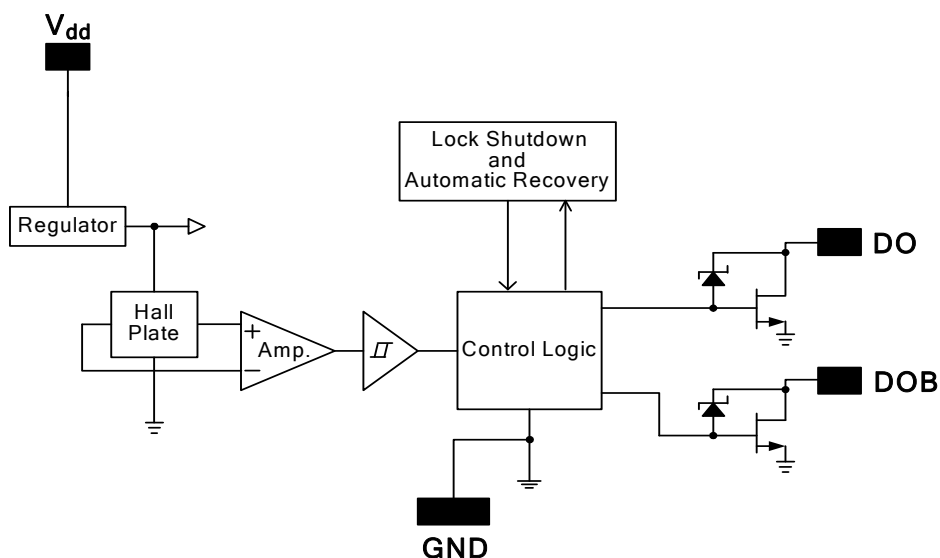

Typical Application Circuit

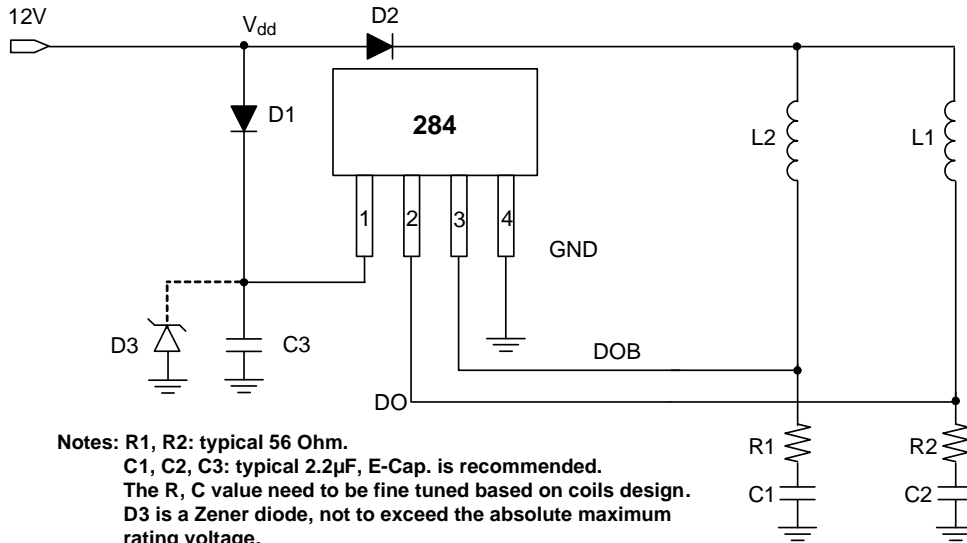

12V Brush-Less DC Fan

Absolute Maximum Ratings ($T_A = 25^\circ\text{C}$)

Symbol	Characteristics	Rating	Unit
V_{dd}	Supply Voltage	24	V
$I_{O(AVE)}$ $I_{O(PEAK)}$	Output Current	SIP-4L SOT89-5L	500
		$I_{O(PEAK)}$	700
P_D	Power Dissipation	SIP-4L SOT89-5L	550 800
T_{ST}	Storage Temperature	-55 ~ 150	$^\circ\text{C}$
T_J	Maximum Junction Temperature	150	$^\circ\text{C}$
θ_{JA} (Note 5)	Thermal Resistance Junction-to-Case	SIP-4L SOT89-5L	227 156

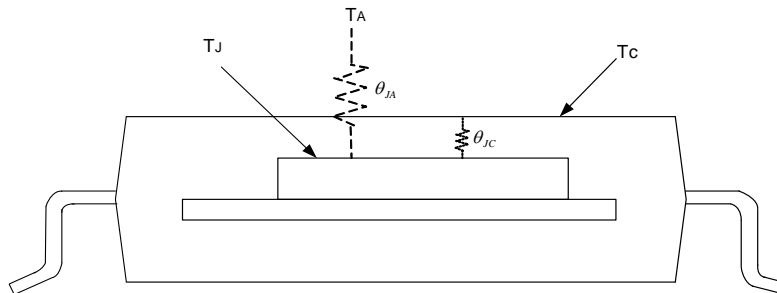

Notes: 5. θ_{JA} should be confirmed with what heat sink thermal resistance. If no heat sink contacting, θ_{JA} is almost the same as θ_{JC} .

Recommended Operating Conditions

Symbol	Characteristic	Conditions	Min	Max	Unit
V _{dd}	Supply Voltage	Operating	3.8	20	V
T _A	Operating Ambient Temperature	Operating	-40	100	°C

Electrical Characteristics (T_A = 25 °C, V_{dd} = 12V, unless otherwise specified)

Symbol	Characteristics	Conditions	Min	Typ.	Max	Unit
V _{dd}	Supply Voltage	Operating	3.8	-	20	V
I _{dd}	Supply Current	Operating	-	2.0	4.0	mA
I _{off}	Output Leakage Current	V _{OUT} = 24V	-	< 0.1	10	μA
T _{Irp-on}	Locked Protection On		0.4	0.5	0.6	Sec
T _{Irp-off}	Locked Protection Off		2.4	3	3.6	Sec
V _{OUT(SAT)}	Output Saturation Voltage	I _O = 300mA	-	375	500	mV
		I _O = 500mA	-	625	900	
R _{ds(on)}	Output On Resistance	I _O = 300mA	-	1.25	1.67	ohm
V _Z	Output Zener-Breakdown Voltage		35	42	60	V

Truth Table

IN-	IN+	CT	OUT1	OUT2	Mode
H	L	L	H	L	Rotating
L	H	L	L	H	Rotating
-	-	H	off	off	Lockup protection activated

Magnetic Characteristics (T_A = 25 °C, V_{dd} = 12V, unless otherwise specified)

(1mT = 10 Gauss)

Symbol	Characteristics	Min	Typ.	Max	Unit
B _{op}	Operation Point	10	30	60	Gauss
B _{rp}	Release Point	-60	-30	-10	Gauss
B _{hy}	Hysteresis	--	60	--	Gauss

Operating Characteristics

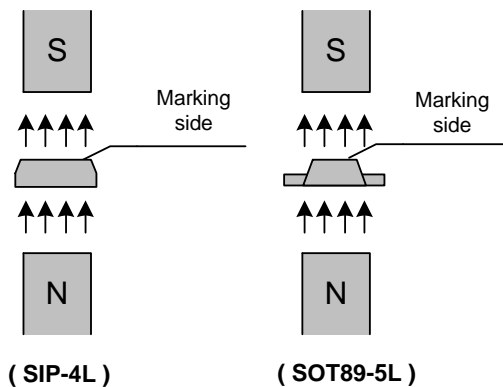
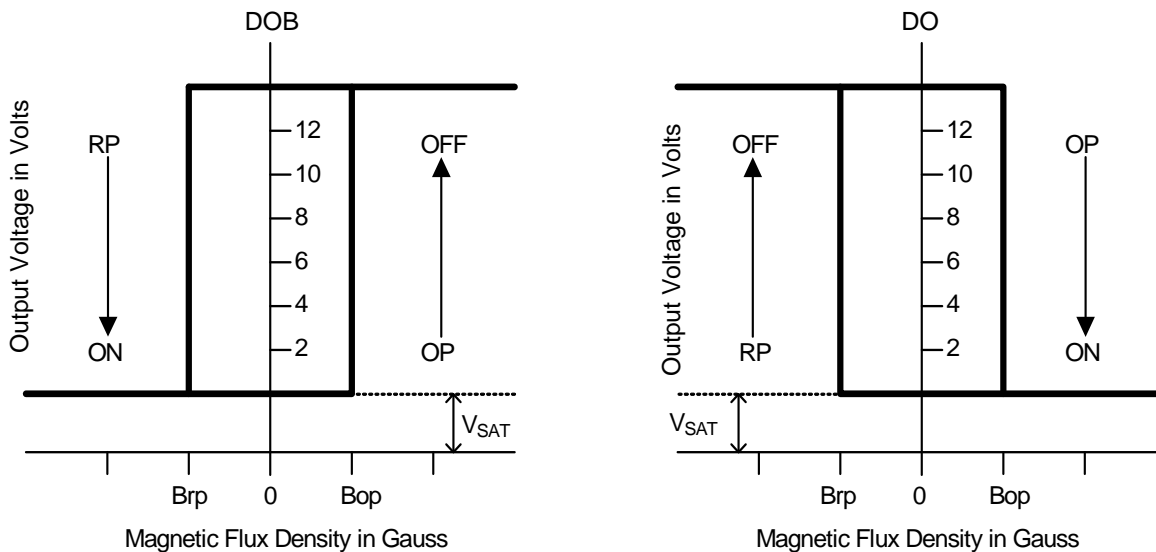

Performance Characteristics

(1) SIP-4L

T_A (°C)	25	50	60	70	80	85	90	95	100
P_D (mW)	550	440	396	352	308	286	264	242	220
T_A (°C)	105	110	115	120	125	130	135	140	150
P_D (mW)	198	176	154	132	110	88	66	44	0

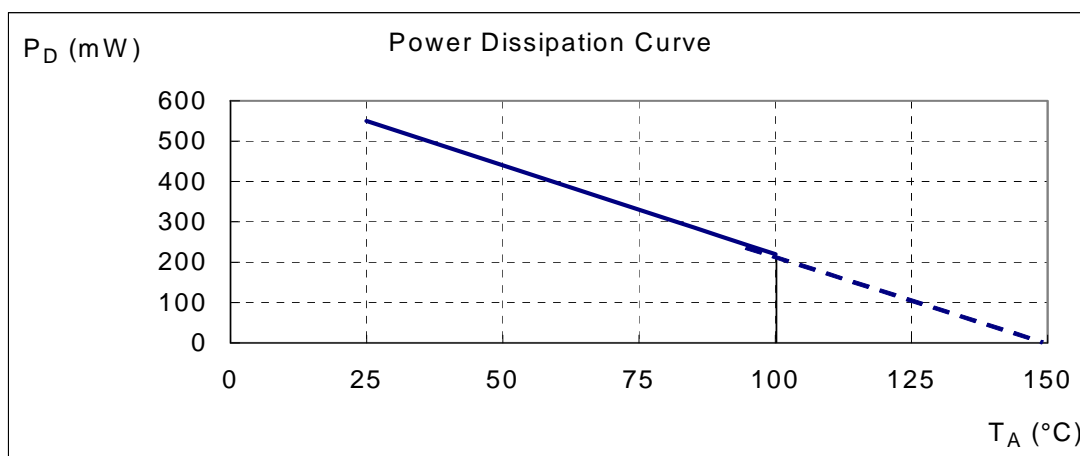

(2) SOT89-5L

T_A (°C)	25	50	60	70	75	80	85	90	95	100
P_D (mW)	800	640	576	512	480	448	416	384	352	320
T_A (°C)	105	110	115	120	125	130	135	140	145	150
P_D (mW)	288	256	224	192	160	128	96	64	32	0

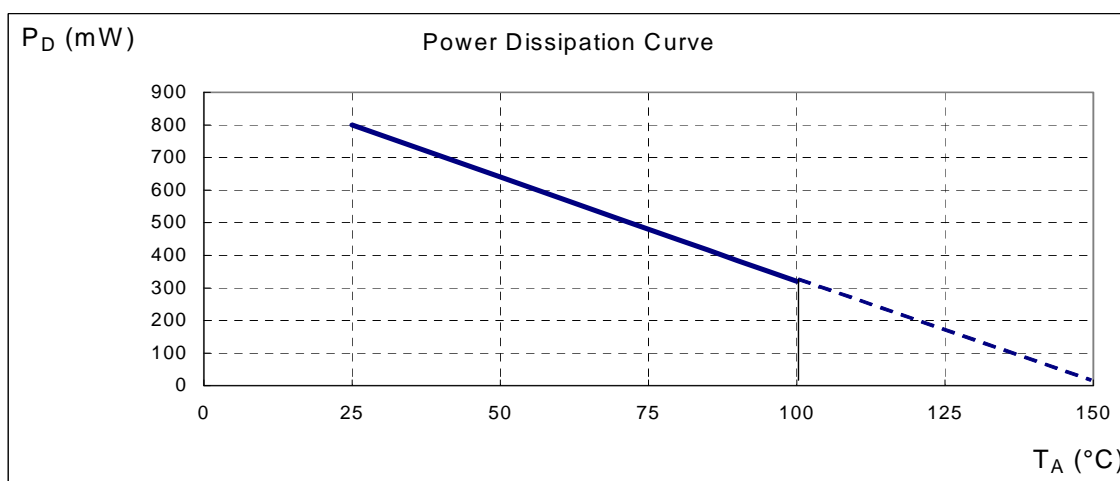

Marking Information

(1) SIP-4L

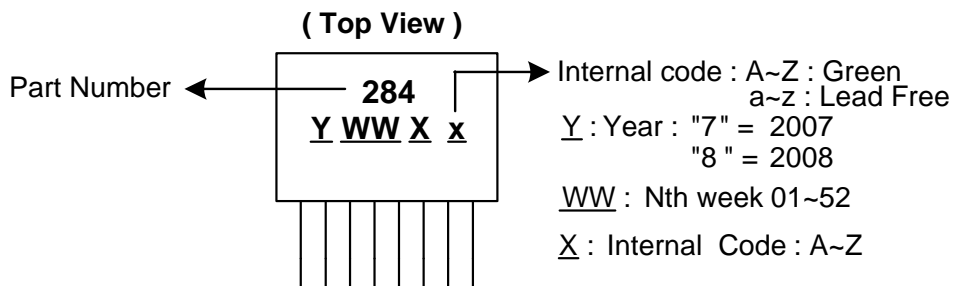

(2) SOT89-5L

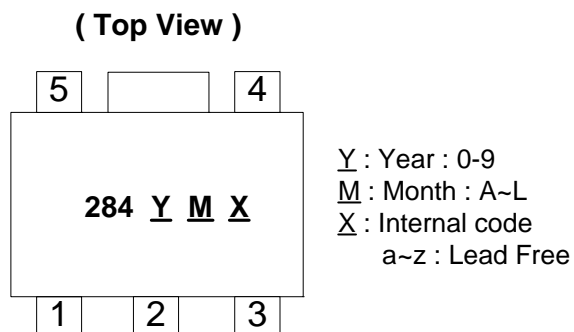

Package Information (All Dimensions in mm)

(1) Package type: SIP-4L

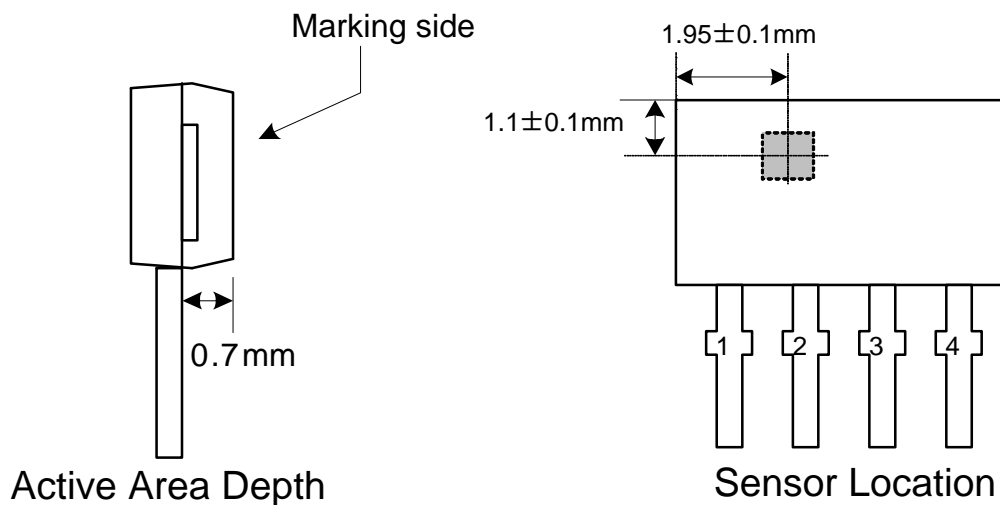

Package Dimension

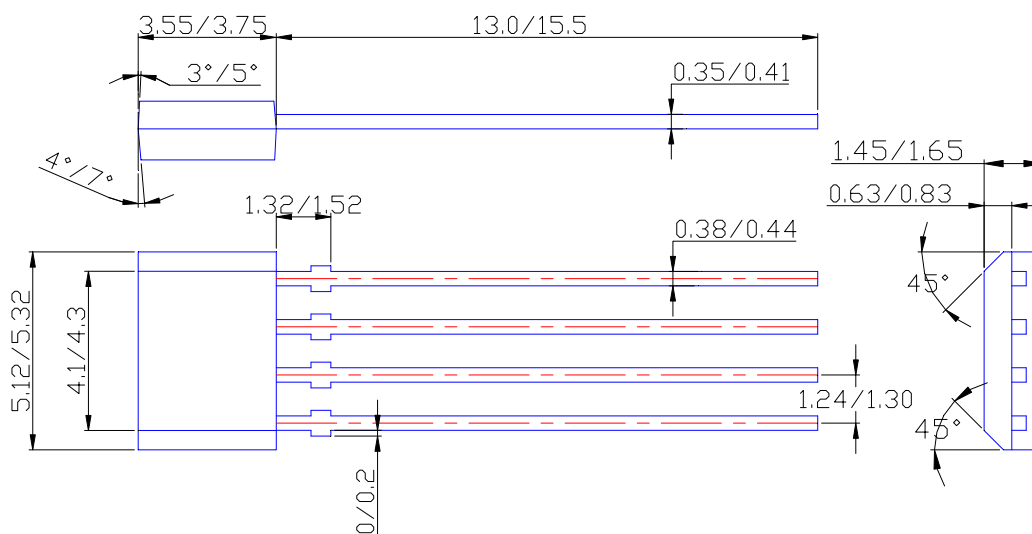

Package Information (Continued)

(2) Package type: SOT89-5L

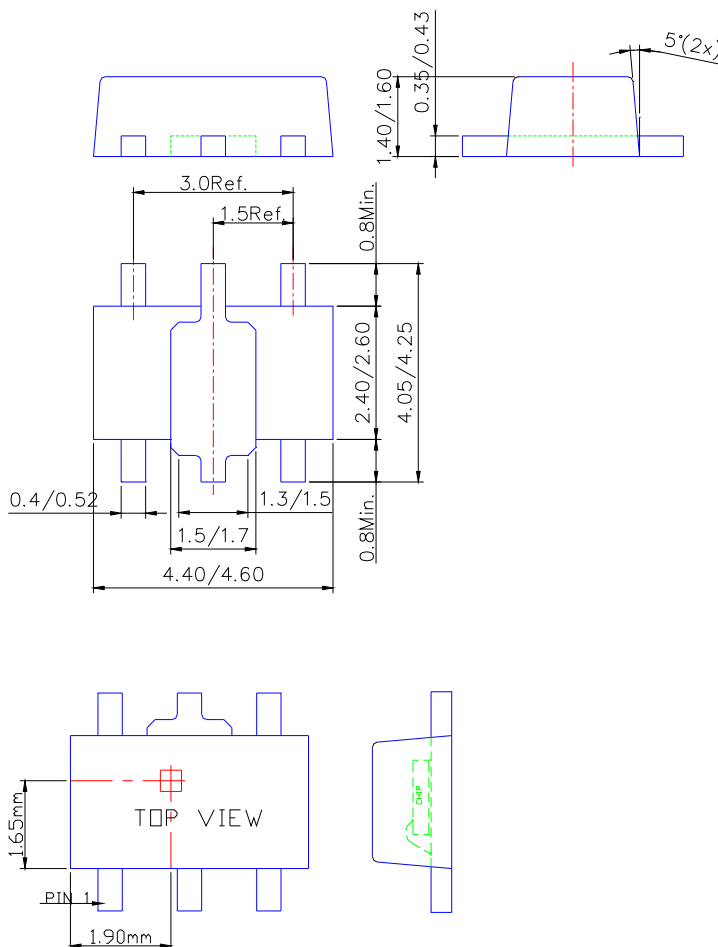

Sensor Location

IMPORTANT NOTICE

Diodes Incorporated and its subsidiaries reserve the right to make modifications, enhancements, improvements, corrections or other changes without further notice to any product herein. Diodes Incorporated does not assume any liability arising out of the application or use of any product described herein; neither does it convey any license under its patent rights, nor the rights of others. The user of products in such applications shall assume all risks of such use and will agree to hold Diodes Incorporated and all the companies whose products are represented on our website, harmless against all damages.

LIFE SUPPORT

Diodes Incorporated products are not authorized for use as critical components in life support devices or systems without the expressed written approval of the President of Diodes Incorporated.